Comfort-Cire®

Century®

MARS
Delivering Confidence

PARTS LIST

Horizontal/Side Discharge Condensing Units

CMA1424SF-1

EXPLODED VIEW

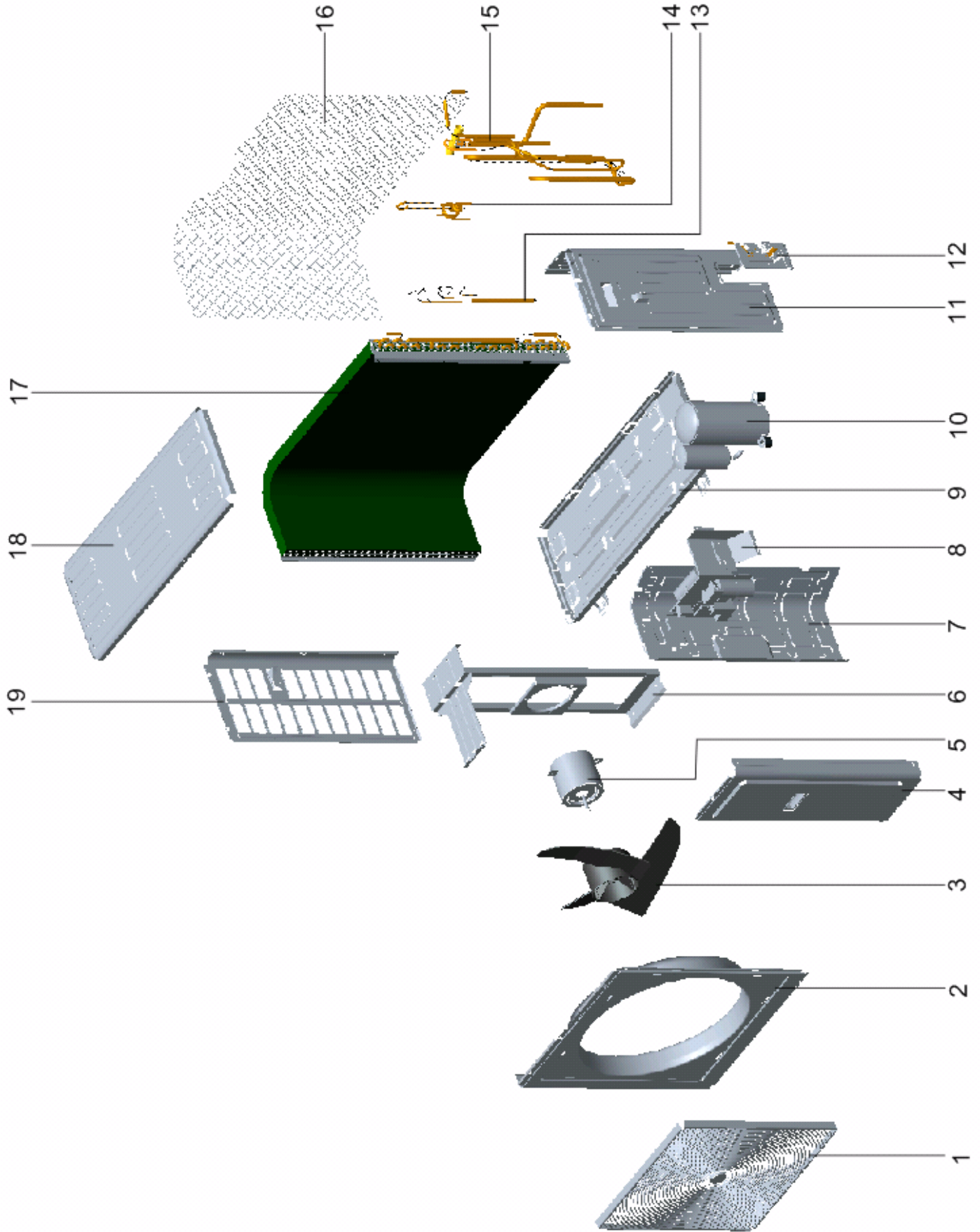

REPLACEMENT PARTS

Location	Part Name	Quantity	Part No.
1	Net cover	1	802928290002
2	Panel	1	801219900681
3	Propeller fan	1	801100300040
4	Maintenance panel	1	801228290041
5	Outdoor motor(YDK-150-6CH)	1	802400400592
6	Support for motor	1	801219900680
7	Median bulkhead	1	801219900686
8	Control assembly	1	803328290020
9	Chassis	1	801232890019
10	Compressor assy	1	801432890002
11	Right separating board parts	1	801219900682
12	Base board for valve assy	1	801232890044
12.1	Base board for valve	1	801219900676
12.2	Service valve (liquid)	1	801600200014
12.3	Service valve (gas)	1	801600200011
13	Shunt capillary module	1	801632890121
14	Condenser collector assembly	1	801632890122
15	Piping assembly	1	801632890125
16	Back mesh	1	801132990002
17	Condenser	1	801532890031
18	Top cover board	1	801228290042
19	Left separating board	1	801228290037

Due to ongoing product improvements, specifications and dimensions are subject to change and correction without notice or incurring obligations. Determining the application and suitability for use of any product is the responsibility of the installer. Additionally, the installer is responsible for verifying dimensional data on the actual product prior to beginning any installation preparations.

Incentive and rebate programs have precise requirements as to product performance and certification. All products meet applicable regulations in effect on date of manufacture; however, certifications are not necessarily granted for the life of a product. Therefore, it is the responsibility of the applicant to determine whether a specific model qualifies for these incentive/rebate programs.

Comfort-Aire®

1900 Wellworth Ave., Jackson, MI 49203 • Ph. 517-787-2100 • www.marsdelivers.com

